

LSC

Submersible Residue Dewatering Pump

LSP

Self-Priming Residue Dewatering Pump

OPERATION MANUAL

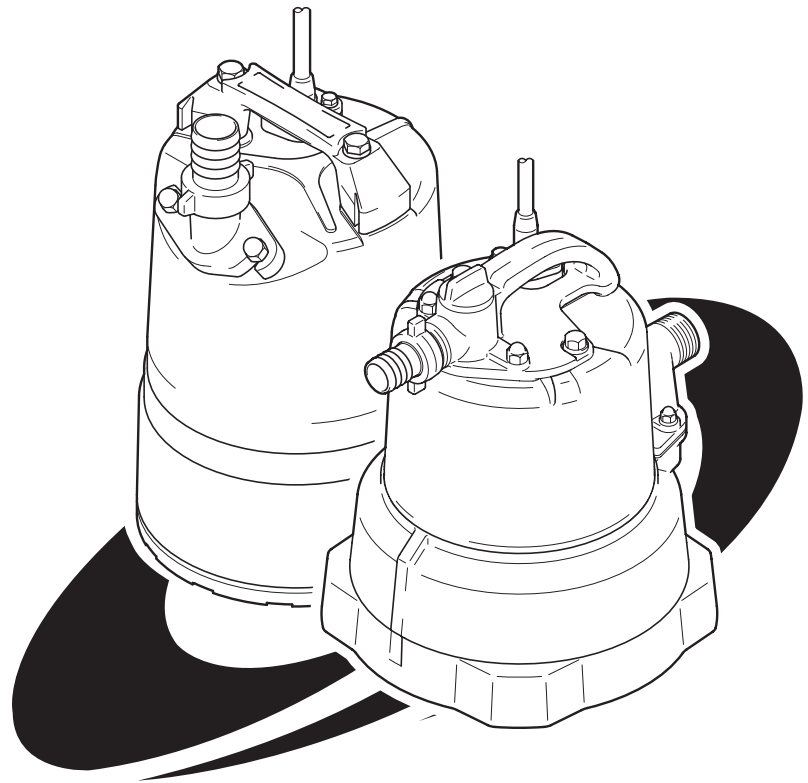

INTRODUCTION

Thank you for selecting the Tsurumi LSC Submersible Residue Dewatering Pump and LSP Self-Priming Residue Dewatering Pump for your application.

This equipment should not be used for applications other than those listed in this manual. Failure to observe this precaution may lead to a malfunction or an accident. In the event of a malfunction or an accident, the manufacturer will not assume any liability. After reading this Operation Manual, keep it in a location that is easily accessible, so that it can be referred to whenever information is needed while operating the equipment.

CONTENTS

1. BE SURE TO READ FOR YOUR SAFETY	1
2. PART NAMES	4
3. PRIOR TO OPERATION	5
4. INSTALLATION	6
5. ELECTRICAL WIRING	8
6. OPERATION.....	10
7. MAINTENANCE AND INSPECTION	11
8. DISASSEMBLY AND REASSEMBLY PROCEDURE	12
9. TROUBLESHOOTING	15



1 BE SURE TO READ FOR YOUR SAFETY

Be sure to thoroughly read and understand the SAFETY PRECAUTIONS given in this section before using the equipment in order to operate the equipment correctly.

The precautionary measures described in this section are intended to prevent danger or damage to you or to others. The contents of this manual that could possibly be performed improperly are classified into two categories: **⚠ WARNING**, and **⚠ CAUTION**. The categories indicate the extent of possible damage or the urgency of the precaution. Note however, that what is included under **⚠ CAUTION** may at times lead to a more serious problem. In either case, the categories pertain to safety-related items, and as such, must be observed carefully.

- **⚠ WARNING** : Operating the equipment improperly by failing to observe this precaution may possibly lead to death or injury to humans.
- **⚠ CAUTION** : Operating the equipment improperly by failing to observe this precaution may possibly cause injury to humans and other physical damage.
- **NOTE** : Gives information that does not fall in the WARNING or CAUTION categories.

● Explanation of Symbols:



-  : The \triangle mark indicates a WARNING or CAUTION item. The symbol inside the mark describes the precaution in more detail ("electrical shock", in the case of the example on the left).
-  : The \circ mark indicates a prohibited action. The symbol inside the mark, or a notation in the vicinity of the mark describes the precaution in more detail ("disassembly prohibited", in the case of the example on the left).
-  : The \bullet mark indicates an action that must be taken, or instructs how to perform a task. The symbol inside the mark describes the precaution in more detail ("provide ground work", in the case of the example on the left).

PRECAUTIONS TO THE PRODUCT SPECIFICATIONS

⚠ CAUTION	
	<ul style="list-style-type: none"> ● Do not operate the product under any conditions other than those for which it is specified. Failure to observe the precaution can lead to electrical leakage, electrical shock, fire, or water leakage, etc.









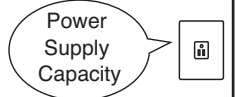





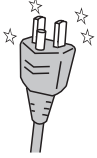

PRECAUTIONS DURING TRANSPORT AND INSTALLTION























⚠ WARNING	
	<ul style="list-style-type: none"> ● When transporting the product, pay close attention to its center of gravity and mass. Use an appropriate lifting equipment to lift the unit. Improper lifting may result in the product damage, injury, or death.
	<ul style="list-style-type: none"> ● Electrical wiring should be performed in accordance with all applicable regulations in your country. Provide a dedicated earth leakage circuit breaker and a thermal overload relay for the pump. Imperfect wiring or neglecting the installation of proper equipment will cause electrical leakage, fire, or explosion at worst.
	<ul style="list-style-type: none"> ● Use a power outlet that has a sufficient rating and has been exclusively provided for the pump. If the power outlet is shared with other equipment, it can lead to an abnormal heat of the outlet and can cause fire as a result.

⚠ WARNING





 CAUTION	
 <ul style="list-style-type: none"> ● Be sure to provide a ground wire securely. Do not connect the ground wire to a gas pipe, water pipe, lightning rod, or telephone ground wire. Improper grounding could cause electrical shock. 	 <ul style="list-style-type: none"> ● Prevent a metallic object or dust from sticking to the power plug. Adhesion of foreign object to the plug could cause electrical shock, short-circuit, or fire. 
 <ul style="list-style-type: none"> ● Do not scratch, fold, twist, make alterations, or bundle the cable, or use it as a lifting device. The cable may be damaged, which may cause electrical leakage, short-circuit, electrical shock, or fire. 	 <ul style="list-style-type: none"> ● Do not use the cable, power plug, or power outlet if it is damaged or it is not closely fitted. Connect every conductor of the cable securely to the terminals. Failure to observe this can lead to electrical shock, short-circuit, or fire. 
 <ul style="list-style-type: none"> ● This pump is neither dust-proof nor explosion-proof. Do not use it at a dusty place or at a place where toxic, corrosive or explosive gas is present. Use in such places could cause fire or explosion. 	 <ul style="list-style-type: none"> ● When transporting or installing the pump, bring it with the handle. When lifting the product, tie a rope to the handle tightly. Transporting or lifting the pump with its cable may damage the cable, which may cause electrical leakage, electrical shock, or fire. 
 <ul style="list-style-type: none"> ● If a hose is used for the discharge line, take a measure to prevent the hose from shaking. If the hose shakes, you may be wet or injured. 	

PRECAUTIONS DURING TEST OPERATION AND OPERATION

 WARNING	
 <ul style="list-style-type: none"> ● Never start the pump while it is suspended, as the unit may jerk and could lead to injury. 	 <ul style="list-style-type: none"> ● When inspecting the pump, be sure to turn off the power supply (earth leakage circuit breaker, etc.) so that the pump may not start accidentally. Failure to do so may lead to a serious accident. 
 CAUTION	
 <ul style="list-style-type: none"> ● Do not operate the product under any voltage other than described on the nameplate with the voltage variation limit within $\pm 10\%$. If it is operated with a generator, it is strongly suggested not to operate other equipment with the same generator. Failure to observe this caution may cause malfunction and breakdown of the product, which may lead to electrical leakage or electrical shock. 	 <ul style="list-style-type: none"> ● Do not touch the product with bare hands during or immediate after the operation, as the product may become very hot during operation. Failure to observe this caution may lead to be burned. Especially, when opening the priming plug, pay attention to a phenomenon that hot water may spout from the pump. 
 <ul style="list-style-type: none"> ● Do not use the product in a liquid other than water. Use in oil, salt water or organic solvents will damage it, which may lead to electrical leakage or electrical shock. 	 <ul style="list-style-type: none"> ● Do not run the product dry or operate it with its valve (sluice or gate valve) closed, as doing so will damage the product, which may lead to electrical leakage or electrical shock. 
 <ul style="list-style-type: none"> ● Do not use the product for hot or warm liquid over 40°C, as doing so will damage the product, which may lead to electrical leakage or electrical shock. 	 <ul style="list-style-type: none"> ● When operating the pump with its valve (sluice or gate valve) closed, it may become very hot. Be careful not to contact the pump accidentally to avoid being burned.
 <ul style="list-style-type: none"> ● Do not allow foreign objects (metal objects such as pins or wires) to enter the suction inlet of the pump. Failure to observe this caution could cause it to malfunction or to operate abnormally, which may lead to electrical leakage or electrical shock. 	 <ul style="list-style-type: none"> ● When the product will not be used for an extended period, be sure to turn off the power supply (earth leakage circuit breaker, etc.). Deterioration of the insulation may lead to electrical leakage, electrical shock, or fire.  

PRECAUTIONS DURING MAINTENANCE AND INSPECTION

⚠ WARNING	
	<p>● Absolutely turn off the power supply before starting maintenance or inspection, and perform the work after making sure that the impeller has stopped completely. Do not work with wet hands. Failure to observe these cautions may lead to electrical shock or injury.</p>
	<p>● In case any abnormality (excessive vibration, unusual noise or odor) is found in the operation, turn the power off immediately and consult with the dealer where it was purchased or Tsurumi representative. Continuing to operate the product under abnormal conditions may result in electrical shock, fire, or water leakage.</p>
⚠ CAUTION	
	<p>● After reassembly, always perform a test operation before resuming use of the product. Improper assembly can result in electrical leakage, electrical shock, fire, or water leakage.</p>

PRECAUTION TO POWER OUTAGE

⚠ WARNING	
	<p>● In case of power outage, turn off the power supply. The product will resume operation when the power is restored, which presents serious danger to people in the vicinity.</p>

OTHER PRECAUTION

⚠ CAUTION	
	<p>● Never use the product for potable water. It may present a danger to human health.</p>

2 PART NAMES

■ LSC1.4S

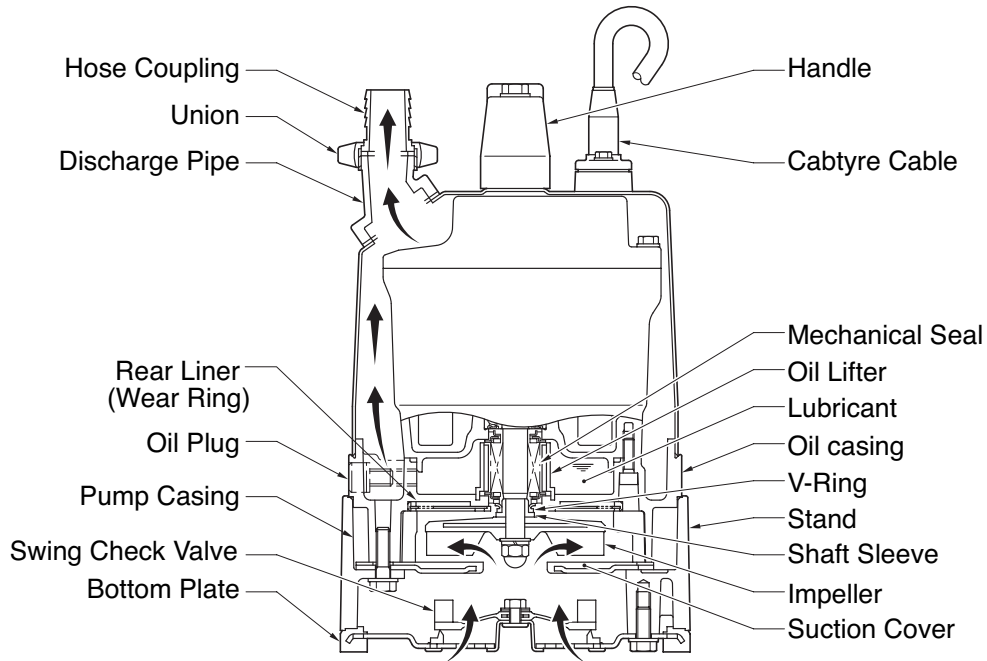

■ LSP1.4S

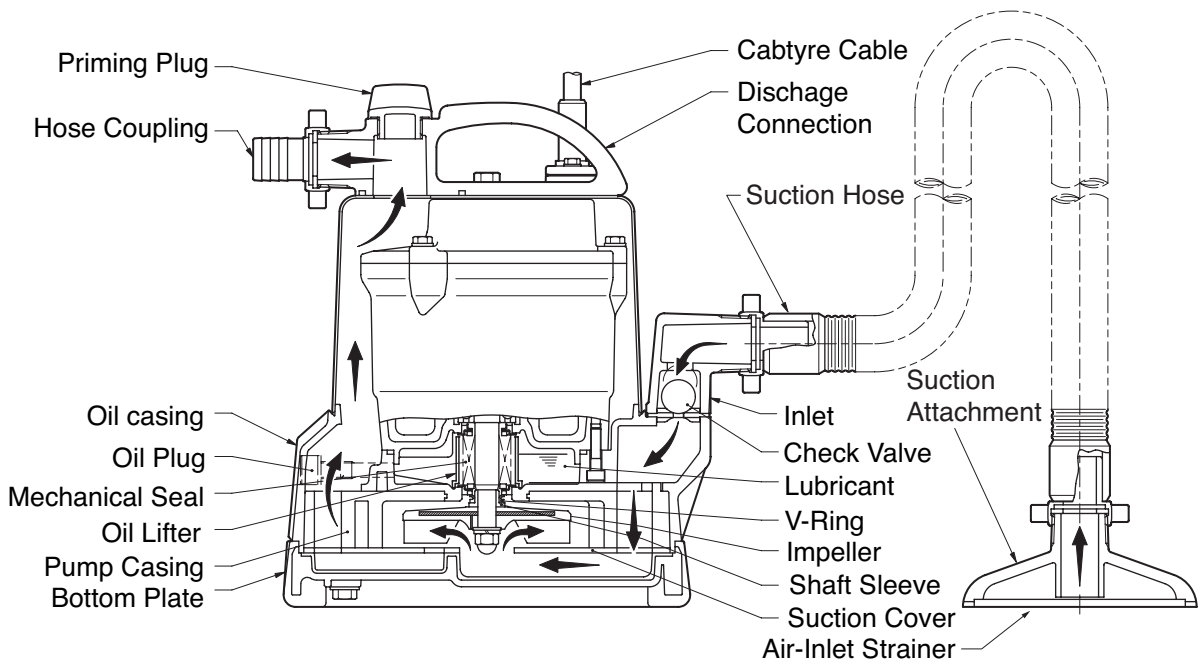

3 PRIOR TO OPERATION

When the pump is delivered, first perform the following checks.

Product Inspection

While unpacking, inspect the product for damage during shipment, and make sure all bolts and nuts are tightened properly.

Specification Check

Check the model number to make sure it is the product that was ordered. Be certain it is the correct voltage and frequency.

Accessory Check

Verify that all accessory items are included in the package.

LSC Type

- Hose Band 1 pc
- ø25mm Hose Coupling with Union Hose Band 1 set
- Operation Manual 1

LSP Type

- ø25mm Hose Coupling with Union Hose Band 1 set
- Suction Hose with Union (5m) 1 set
- Suction Attachment 1 set
- Operation Manual 1

Note: *If there is any problem with the product as shipped, contact your nearest dealer or Tsurumi representative at once.*

Product Specifications



CAUTION

Do not operate this product under any conditions other than those for which it is specified. Failure to observe this precaution can lead to electrical shock, electrical leakage, fire, water leakage or other problems.

Major Standard Specifications

Applicable Liquids	Consistency and Temperature	Cleaning Water, Water on floor Puddles (LSC1.4S). Residual water, Puddles (LSP1.4S) ; 0 ~ 40°C
Pump	Impeller	Semi-Vortex Type
	Shaft Seal	Double Mechanical Seal
	Bearing	Shielded Ball Bearing
Motor	Specifications	Dry Submersible Induction Motor (2-Pole)
	Insulation	Class E
	Protection System (built-in)	Miniature Protector
	Lubricant	Turbine Oil ISO VG32 (non-additive)
Connection		Hose Coupling

Standard Specifications (50/60 Hz)

Model	Bore (mm)	Phase	Starting Method	Output kW (HP)	Max. Head m(ft.)	Max. Capacity m ³ /min(GPM)	Weight kg (lbs.)
LSC1.4S	25	Single	Capacitor Run	0.48 (2/3)	11/12(36/39)	—	12.0 (26.5)
LSP1.4S	25	Single	Capacitor Run	0.48 (2/3)	8/9(26.2/29.5)	0.06(15.8)	12.5 (27.6)

Note: *The mass (weight) given above is the dry weight of the pump itself, not including the cable.*

4 INSTALLATION



CAUTION

- Do not use the pump in liquids other than plain water, such as oil, salt water, or organic solvents.
- Use with a power supply voltage within $\pm 10\%$ of the rated voltage.
- Do not use in the water temperatures outside the range of $0 \sim 40^{\circ}\text{C}$, which can lead to failure, electrical leakage or shock.
- Do not use in the vicinity of explosive or flammable materials.
- Use only in fully assembled state.

Note: Consult your local dealer or Tsurumi representative before using with any liquids other than those indicated in this document.

■ Maximum allowable water pressure



CAUTION

Do not use at greater than the water pressure shown below.

Maximum allowable water pressure : 0.2MPa (2kgf/cm²) - discharge pressure during use

► Preparation for Installation

Before installing the pump at a work site, you will need to have the following tools and instruments ready.

- AC voltmeter
- AC ammeter (clamp-on type)
- Bolt and nut tighteners
- Power supply connection tools (screwdriver or box wrench)

Note: Please read also the instructions that come with each of the test instruments.

► Checks to make before Installation

Use the insulation resistance tester to measure the motor insulation resistance between the cabtyre cable plug tips and ground.

Note: The reference insulation resistance (20M Ω or greater) is the value when the pump is new or has been repaired. For the reference value after installation, see below at Maintenance and Inspection (p. 11).

Precautions in Installation

WARNING When installing the pump, pay close attention to its center of gravity and weight. If it is not lowered into place correctly, it may fall and be damaged or cause injury.

CAUTION Do not under any circumstances install or move the pump by suspending it from the cabtyre cable. The cable may be damaged, causing electrical leakage, shock, or fire.

(1) •Model LSC
The discharge connection is fitted with a 25 mm diameter union hose coupling. Attach the hose coupling as far as it will go, then fasten it securely with the hose band.

•Model LSP
Attach the hose to the hose coupling as far as it will go, then fasten it securely with the hose band. At the inlet, use the hose supplied with the pump.

Note: Before connecting the suction attachment, etc., make sure there is packing in the union at both the discharge and inlet hose ends. Even a slight amount of leakage or clogging will greatly affect performance.

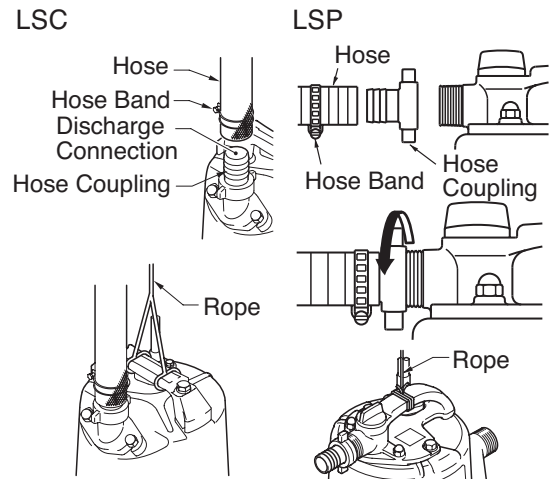

(2) Avoid dropping the pump or other strong impact. Lift the pump by holding it firmly with the hands or by attaching a rope or chain to the handle.

CAUTION The rope for suspending the pump during its installation must be of a thickness that accommodates the weight of the pump. When using a chain, make sure that the chain does not become twisted. Failure to observe these precautions could cause the rope or chain to break and the pump to fall and break, which could lead to personal injury.

Note: On cabtyre cable handling, see at electrical Wiring.

CAUTION Operating the pump when the inlet is blocked with debris will result in excessive noise and vibration, which can cause the pump to malfunction, leading to electrical leakage and shock.

Note: This pump is supplied without piping. Use it with suitable piping material. When used with a hose, pay attention to the following precautions. Make sure the hose has no sharp bends, which can severely limit the flow of water. In particular, sharp bends near the base may cause air pockets to form resulting in idle operation. Lessen the degree of bedding while continuing to operate the pump. The tip of the hose (discharge end) should be located higher than the water surface. If the end of the hose is submerged, water may flow back to the pump when the pump is stopped; and if the hose end is lower than the water surface, water may overflow when the pump is turned off.

CAUTION If large quantities of earth are sucked up, damage resulting from abrasion in the pump can lead to electrical leakage and shock.

(3) Use the pump in the upright position and on a flat surface. If the pump is likely to suck up sand or debris, mount it in a protective box or enclose it with a screen.

Note: In the case of the LSP, installing the pump on an incline will alter the available circulation water capacity, lowering pump performance or even resulting in a total loss of suction.

5 ELECTRICAL WIRING

Performing electrical wiring

- WARNING**
- Electrical wiring should be performed by a qualified person in accord with all applicable regulations. Failure to observe this precaution not only risks breaking the law but is extremely dangerous.
 - Incorrect wiring can lead to electrical leakage, electrical shock or fire.
 - Absolutely provide a dedicated earth leakage circuit breaker and a thermal overload relay suitable for the pump (available on the market). Failure to follow this warning can cause electrical shock or explosion when the product fails or an electrical leakage occurs.

Provide an extra allowance in the capacity of power supply and wiring.

Grounding

- WARNING** Do not use the pump without first grounding it properly. Failure to ground it can lead to electrical shock from an electrical leak or pump malfunction.

- CAUTION** Do not attach the grounding wire to a gas pipe, water pipe, lightning arrestor or telephone grounding wire. Improper grounding can result in electrical shock.

Connecting the power supply

- WARNING** Before connecting leads to the terminal strip, make certain the power supply is turned off (circuit breaker, etc.), to avoid electrical shock, shorting, or unexpected starting of the pump, leading to injury.

- WARNING** Before inserting the power supply plug, make certain the power supply is turned off (circuit breaker, etc.), to avoid electrical shock, shorting, or unexpected starting of the pump, leading to injury.

- CAUTION** Do not use the product with the cable or plug connected loosely, which can result in electric shock, shorting, or fire.

- CAUTION** Draw power from a dedicated power outlet having sufficient capacity for the pump. Sharing the outlet with other equipment may cause overheating at the branch outlet and could result in fire.

When using a three-prong grounded plug, connect as shown in the drawing.

- CAUTION** Be sure to use a dedicated power supply with a ground leakage circuit breaker.

When a single-phase power source is used, connect the leads to the control panel terminals as shown in the diagram, making sure they do not become twisted together.

Note: *The shape of the plug may differ from that shown in the illustration.*

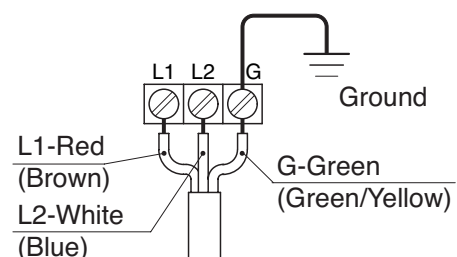
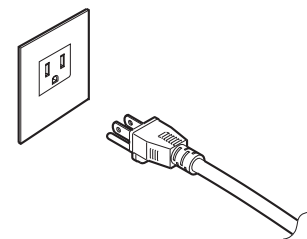

▀ Cabtyre cable



CAUTION

- If it is necessary to extend the cabtyre cable, use a core size equal to or larger than the original. This is necessary not only for avoiding a performance drop, but to prevent cable overheating which can result in fire, electrical leakage or electrical shock.
- If a cable with cut insulation or other damage is submerged in the water, there is danger of water seeping into the motor causing a short. This may result in damage to the pump, electrical leakage, electrical shock, or fire.
- Be careful not to let the cabtyre cable be cut or become twisted. This may result in damage to the pump, electrical leakage, electrical shock, or fire.
- If it is necessary to submerge the connection leads of the cabtyre cable in water, first seal the leads completely in a molded protective sleeve, to prevent electrical leakage, electrical shock, or fire.

Do not allow the cabtyre cable leads or power supply plug to become wet.

Make sure the cable does not become excessively bent or twisted, and does not rub against a structure in a way that might damage it.

▀ Electrical Circuit Diagrams

LSC , LSP

Power Source
Single Phase

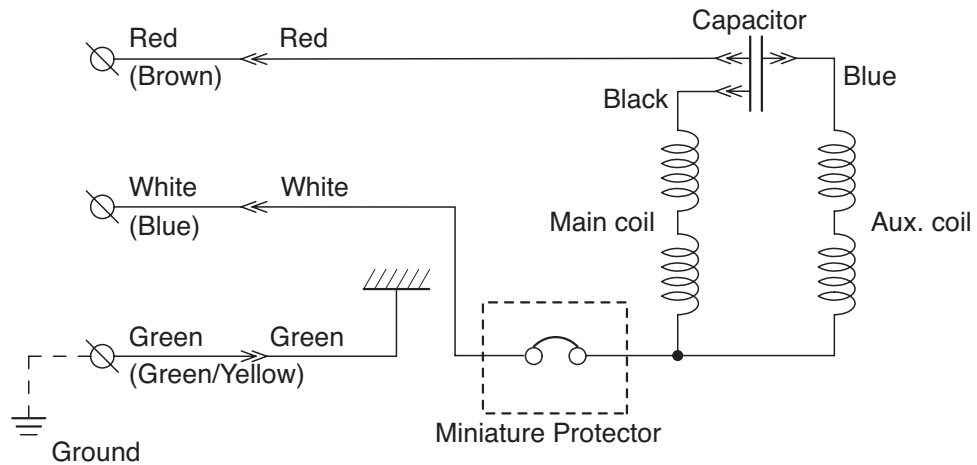

▀ Motor Protection system

The pump is equipped with a built-in motor protector .

If an excessive current is detected or the motor overheats, for reasons such as the following, the pump will automatically stop operating regardless of the water level, to protect the motor.

- Change in supply voltage
- Overload
- Operation under constraint

Note: *Always determine the cause of the problem and resolve it before resuming operation, Simply repeating cycles of stopping and restarting will end up damaging the pump, Do not continue operation at very low water levels or when the suction strainer is clogged with debris. Not only will performance suffer, but such conditions may cause noise, heavy vibration, and malfunctioning.*

6 OPERATION

Before starting

- (1) Make sure once again that the product is of the correct voltage and frequency rating.

CAUTION Using the product at other than rated voltage and frequency will not only lower its performance but may damage the product.

Note: Confirm the rated voltage and frequency on the model name plate.

- (2) Confirm the wiring, supply voltage, circuit breaker capacity, and motor insulation resistance.

■ Reference insulation resistance = 20MΩ or greater.

Note: The reference insulation resistance (20MΩ or greater) is the value when the pump is new or has been repaired. For the reference value after installation, see below at Maintenance and Inspection (p.11).

- (3) The setting on the circuit breaker or other overload protector should be made in accord with the rated current of the pump.

Note: See the model name plate on the pump for its rated current.

- (4) When powering the pump with a generator, do not share the generator with other equipment.

Test Operation

WARNING Never Operate the pump while it is suspended in the air. The recoil may result in injury or other major accident.
Never start the pump when people are standing next to it. An electrical leak can result in electrical shock.

- (1) •Model LSC

The Pump will not start until the pump casing is wet. When doing a test operation or if it is desired to start the pump when the remaining water level is low, pour in clean water from the hose coupling. Approximately 2.5 liter of priming water is required.

- Model LSP

Remove the priming plug at the top of the pump and pour in clean water right up to the top: then replace the priming plug and tighten it. Approximately 1.8 liter of priming water is required.

- (2) Run the pump for a short time (3 to 10 minutes) and check its operation.

CAUTION Do not run the pump dry or with shut off condition. This condition may damage the pump or cause it to malfunction and may result in electrical leakage or electrical shock.

CAUTION In case of very excessive vibration, unusual noise or odor, turn off the power immediately and consult with your nearest dealer or Tsurumi representative. Continuing to operate the pump under abnormal conditions may result in electrical shock, fire, or electrical leakage.

Operation

WARNING The pump may become very hot during operation. Be careful not to contact the pump accidentally to avoid being burned.

Always make sure the pump is primed before starting operation.

If the motor protection system operates due to an overload or malfunction, causing the pump to stop, first investigate and remove the cause before restarting.

If LSC is used: After stopping operation, detach the hose from the discharge connector and turn the pump upside-down to remove the water inside the pump.

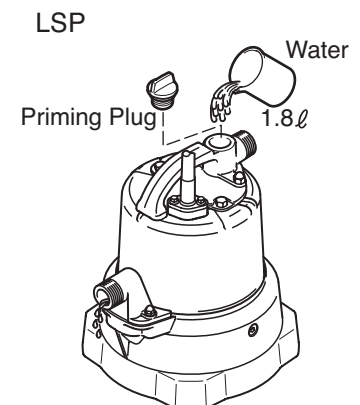

7 MAINTENANCE AND INSPECTION

Regular maintenance and inspections are a necessity for continued efficient functioning of the pump. If any abnormal conditions are noticed, refer to the section on troubleshooting (P.15) and take corrective measures immediately. It is recommended that a spare pump be kept ready in case of any problems.

Prior to Inspecting

WARNING Detach the cabtyre cable from the receptacle or terminals, after making certain the power supply (circuit breaker, etc.) is turned off. Failure to follow this precaution may result in a serious accident from electrical shock or unexpected starting of the pump motor.

- (1) Washing the Pump
Remove accumulated matter from the surface of the pump and wash it with clean water. Take special care to remove any debris from the impeller.
- (2) Inspecting the Pump Exterior
Look for any peeling or chipped paint, and make sure the nuts and bolts are fastened tightly. Any cracks in the surface should be repaired by cleaning that area, drying it and then applying a touchup coating.

Note: Touchup is not supplied. Note that some kinds of damage or looseness may require that the unit be disassembled for repairs. Please consult with your nearest dealer or Tsurumi representative.

Regular Inspection

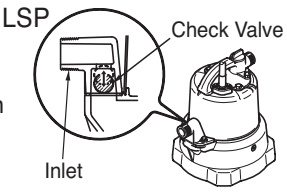
Frequency	Inspection Items
Weekly	Measure insulation resistance ■Reference insulation resistance = 1MΩ minimum NOTE: If the insulation resistance has become notable lower than the previous inspection, an inspection of the motor will be necessary. Measure operating current. ■Compare with rated current Measure supply voltage ■Power supply voltage variation (within ±10% of the rated voltage)
Monthly	Pump Inspection. ■A noticeable drop in performance may indicate wear in the impeller, suction cover, etc., or else clogging of the impeller, etc. Remove the clogged debris, and replace any worn parts. Swing check valve inspection (LSC). ■If the lip on the bottom plate becomes excessively rounded off, or if the rubber material of the swing check valve is deteriorated, shutoff function of the valve decrease. Replace the bottom plate and/or the swing check valve. Check valve inspection (LSP). ■The check valve may fail to operate if sand or debris at attached to it. Wash the valve and inside the inlet at regular intervals. The check valve can be removed by removing the inlet hex.bolt. NOTE: In some case a siphon effect when the pump stops can cause water to reverse its flow or the priming water to flow out. 
Semi-annually	Oil inspection. ■Every 1,000 hours of operation or six months, whichever comes first. Inspection of lifting rope or chain ■ Replace if damage, corrosion, or wear has occurred to the rope or the chain. Remove if foreign object is attaching to it.
Annually	Changing oil. ■Every 2,000 hours of operation or 12 months, whichever comes first. Designated oil: Turbine Oil ISO VG32. Oil Quantity: 155ml (LSC) ; 150ml (LSP) NOTE: See below on OIL inspection and oil change.
Every 2 to 5 years	Change mechanical seal. NOTE: Specialized know-how is required for inspecting and replacing the mechanical seal. Consult with your nearest dealer or Tsurumi representative. Overhaul ■This should be carried out even if there are no problems with the pump. The frequency depends on how continuously the pump is in use. NOTE: Consult with your nearest dealer or Tsurumi representative regarding overhauls.

Storage

When the pump is out of use for an extended period, wash it and dry it thoroughly, then store it indoors.

Note: Always run a test operation before putting the pump back into service.

Oil Inspection and Oil change

Inspecting Oil

Remove the oil plug and tilt the pump to drain a small of oil. If the oil is milky white or has water mixed in with it, the mechanical seal may faulty . In this case the pump will need to be disassembled and repaired.

Replacing oil

Remove the oil plug and drain all the oil, then replace it with the specified amount.

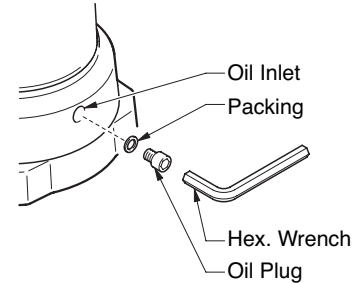

Note: Worn oil and other waste products should be disposed of by a qualified agent, in accord with applicable laws. The oil plug packing should be replaced each time the oil is inspected or changed.

Pump Model	Oil Quantity(ml)
LSC1.4S	155
LSP1.4S	150

Replacement parts

The table lists the parts that need to be replaced periodically. Replace these using the recommended frequency as a guideline.

Note: These parts should be replaced after every 2,000 hours of operation, or when a problem is detected.

Part	Replacement condition
Mechanical Seal	When oil is discolored.
Lubricant ; Turbine Oil VG 32 (non-additive)	Every 2,000 hours or 12 months, whichever comes first.
Packing	Each time pump is disassembled or inspected.
V-Ring	When the lip is worn, and each time pump is disassembled or inspected.
Shaft sleeve	When it becomes worn.
Swing check valve	When the shutoff function decreases

8 DISASSEMBLY AND REASSEMBLY PROCEDURE

■ Prior to Disassembly and Reassembly



WARNING

Before disassembling the pump, first detach the cabtyre cable from the receptacle or terminals, after making certain the power supply (circuit breaker, etc.) is turned off. To avoid electrical shock, do not work with wet hands. Never check the operation of any parts (to check the rotation of the impeller) by turning on the power while the unit is partially assembled. Failure to observe these precautions may result in serious accident. Do not disassemble or repair any parts other than those designated here. If repairs are necessary in any other than the designated parts, consult with your nearest dealer or Tsurumi representative. Improper repairs can result in electrical leakage, electrical shock, fire, or water leaks. After reassembly, always perform a test operation before resuming use of the pump. Improper assembly will cause the pump to malfunction, resulting in electric shock or water leaks.

The procedure for disassembly and reassembly is shown here to the extent necessary for impeller replacement. A specialized environment and facilities are necessary for work on the mechanical seal and the motor parts. Contact your nearest dealer or Tsurumi representative in the event such repairs are necessary.

Disassembly Procedure

Note: Before disassembling, be sure to drain the oil.

- (1) Removing the suction cover and the pump casing
Remove the hex bolts and the sealing washers from under the bottom plate and remove the bottom plate from the pump unit. Then, use a wrench to remove the hex bolt with flat washer to remove the stand, O-ring, suction cover, and the pump casing from the pump unit.
- (2) Removing the impeller
Using a box wrench, remove the hex cap nut, spring washer, and flat washer, to remove the impeller, shaft sleeve, and the V-ring from the main shaft.
- (3) Removing the rear liner
Remove the rear liner from the oil casing.

Disassembly Diagram (LSC1.4S)

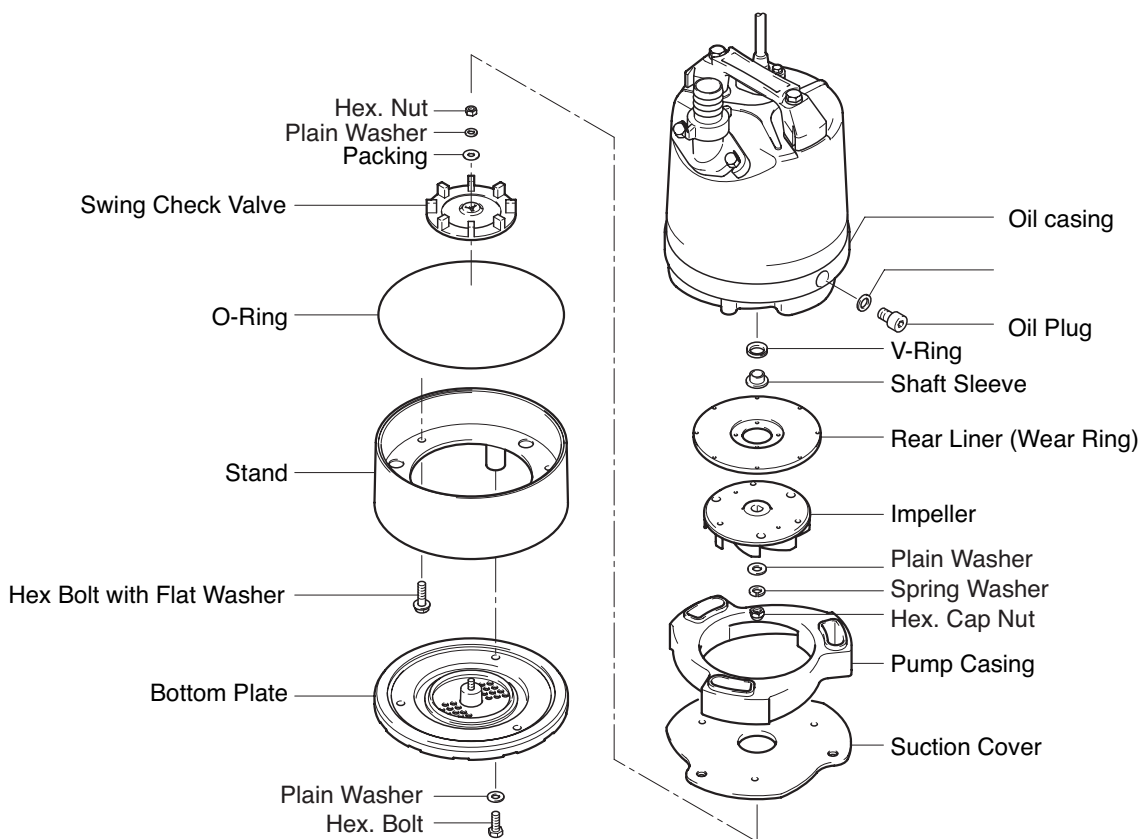

Note: When replacing the check valve, be careful not to overtighten the hexagon nut. Doing so may result in the decrease in its shutoff function.

Reassembly Procedure

Observe the precautions given below and reassemble the unit in the reverse order of disassembly.

Note: The packings must be replaced with a new part. If any part is worn or damaged, make sure to replace it with a new part.

Remove sand or debris from rubber parts (rear liner, impeller, pump casing, and suction cover) before reassembling them.

After installing the impeller and the suction cover, make sure that the impeller rotates smoothly and that it does not interfere with the suction cover.

Disassembly(LSP)

Note: Before disassembly, drain the oil from the pump.

- (1) Remove the Bottom Plate and Suction Cover
Remove the Hex. Bolt and Plain Washer under the Bottom Plate, then remove the Bottom Plate and Suction Cover from the Pump casing.
- (2) Remove the Impeller
With a box wrench or other tool, remove the Impeller Nut, spring washer and Plain Washer, then remove the impeller, Shaft Sleeve and V-Ring from the Shaft. Next, Remove the Pump Casing from pump.

Exploded view(LSP1.4S)

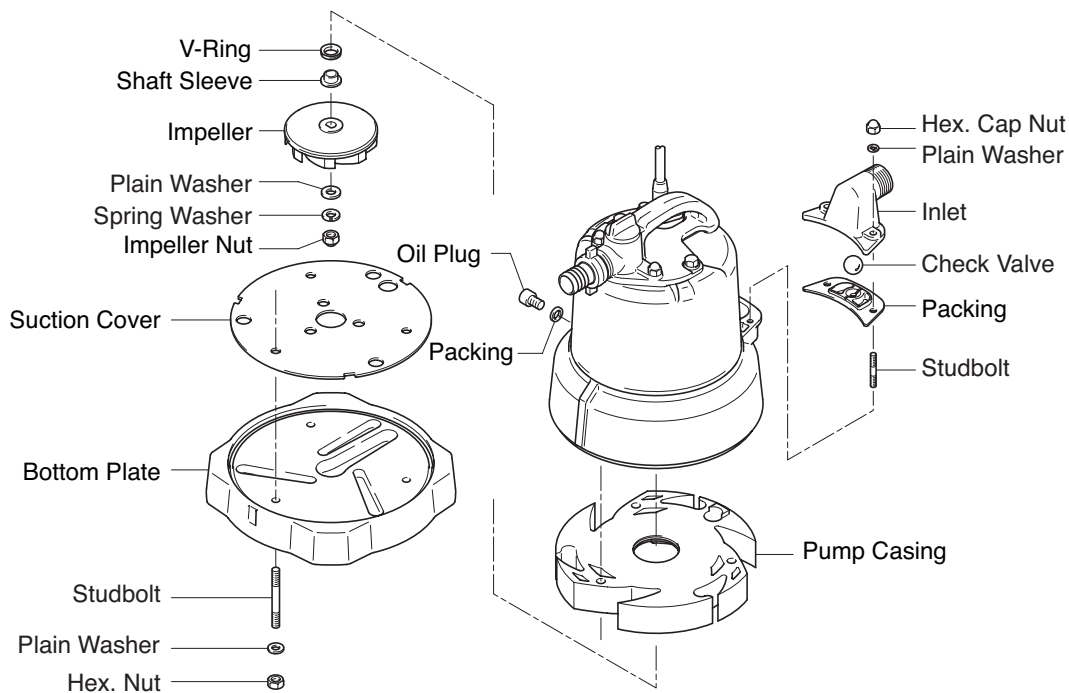

Reassembly

Reassembly can be performed by reversing the steps for disassembly, paying attention to the following points.

Note: Replace the packing each time this operation is performed. Replace any other worn or damaged part as well.

- (1) Mount the V-Ring on the Shaft Sleeve as shown in the diagram. Do not lubricate the surface where the V-Ring contacts the Shaft Sleeve.
- (2) The Pump Casing, Suction Cover and Bottom Plate must be oriented correctly. Use the inlet position as a guide to line up the parts properly, as shown in the diagram.
- (3) When the pump Casing and Bottom Plate are mounted, the air-tightness will greatly affect pump performance. Make sure there is no sand or other debris on the rubber parts.
- (4) When attaching the Check Valve at the Inlet, Make sure the Check Valve lines up with the center of the packing as shown.

After attaching the Impeller, and again after mounting the Suction Cover, Check to make sure the Impeller rotates smoothly.

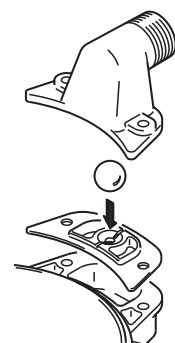
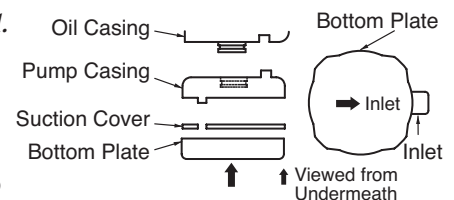
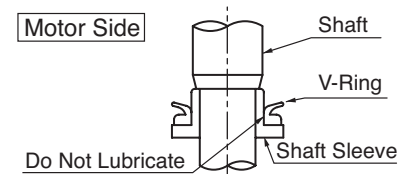

9 TROUBLESHOOTING

⚠ WARNING Always turn off the power before inspecting the pump. Failure to observe this precaution can result in serious accident.

Before ordering repairs, carefully read through this instruction manual, then repeat the inspection. If the problem remains, contact your nearest dealer or Tsurumi representative.

■ LSC

Problem	Possible cause	Countermeasure
Pump fails to start; or, starts but stops immediately (within 10 seconds).	(1)No proper power is supplied (power outage, etc.) (2)Pump is jammed with debris, causing the motor protector to trip.	(1>Contact the electric power company or an electrical repair shop to take action. (2)Inspect the pump unit and remove the debris.
During operation, the pump stops automatically due to the tripping of the motor protector.	(1)The pump casing is filled with mud. (2)The voltage is too low. (3)The pump was operated dry for a prolonged length of time as a result of the clogging of the suction strainer of the bottom plate. It pumps too much mud. (4)A 50Hz pump is operated at 60Hz.	(1)Disassemble and clean the pump. Detach the suction cover, remove the mud, and manually turn the pump. (2)Raise the voltage to the rated voltage. (3)Remove debris. (4)Check the nameplate and replace the pump or the impeller.
The pumping head and volume are small.	(1)The impeller or the suction cover is significantly worn. (2)The drain hose is kinked or clogged. (3)The suction strainer of the bottom plate is clogged. (4)The suction inlet is clogged with debris. (5)A 50Hz pump is operated at 60Hz.	(1)Repair or replace the affected part. (2)Straighten the curved or kinked part as much as possible. (3)Remove debris. (4)Remove the bottom plate to remove the debris from the inside of the suction inlet. (5)Check the nameplate and replace the pump or the impeller.
Does not draw water at low water level.	(1)There is no water in the pump.	(1)Prime the pump.
After the pump stops, the priming water flows out.	(1)The swing check valve and/or the lip on the bottom plate is worn.	(1)Replace the swing check valve and/or the bottom plate.

■ LSP

Problem	Possible cause	Countermeasure
Pump fails to start; or, starts but stops immediately (within 10 seconds).	(1)No proper power is supplied (power outage, etc.) (2)Pump is jammed with debris, causing the motor protector to trip.	(1>Contact the electric power company or an electrical repair shop to take action. (2)Inspect the pump unit and remove the debris.
Pump operates but does not draw water.	(1)There is no priming water or is insufficient. (2)The bottom plate is installed incorrectly. (3)The suction hose or the sweeper suction attachment is not securely connected.	(1)Pour fresh water (approximately 1.8L). (2)Re-install the bottom plate with its arrow facing the suction inlet. (3)Connect it securely.
The pump stops after operating for a predetermined length of time.	(1)The voltage is too low. (2)A 50Hz pump is operated at 60Hz.	(1)Raise the voltage to the rated voltage. (2)Check the nameplate and replace the pump or the impeller.
The pumping head and volume are small. Its suction performance is poor.	(1)The impeller or the suction cover is significantly worn. (2)The drain hose is kinked or clogged. (3)The suction hose or the sweeper suction attachment is clogged or submerged in sand. (4)The suction inlet is clogged with debris. (5)A 50Hz pump is operated at 60Hz.	(1)Repair or replace the affected part. (2)Straighten the curved or kinked part as much as possible. (3)Clean the suction hose and the suction attachment. (4)Remove the suction inlet to clean the suction inlet and the check valve. (5)Check the nameplate and replace the pump or the impeller.
Pump vibrates or makes abnormal sounds.	(1)The motor bearings are damaged.	(1)Replace the bearings.
After the pump stops, the priming water flows out.	(1)The check valve does not function properly because it is stuck with mud.	(1)Clean the check valve and the inside of the suction inlet.

The following information is required when ordering repairs or making other inquiries.

Product model	
Manufacturing number	
Purchase date	
Remarks	

Disposal of Product

Properly dispose of the product by disassembling it, presorting the contents, and sending them to the waste material treatment site.